

DV431AE\*



# Electric Dryer user manual

**Planet  
First** 100%  
Recycled Paper

This manual is made with 100% recycled paper.

imagine the possibilities

Thank you for purchasing this Samsung product.  
To receive more complete service or accessory  
parts, please register your product at or  
contact

[www.samsung.com/register](http://www.samsung.com/register)



# features

---

## 1. Extra Large Capacity

Ultra drying capabilities are at your fingertips! Now you can dry extra-large loads. Our ultra large 10 kg dryer circulates more air through your clothes, drying them faster for a wrinkle-free result.

## 2. Sanitize course

This course allows you to sanitize garments by permeating high temperature heat deep into the fabric during the drying cycle. Use this course to keep your bedding and curtains clean. When selecting this cycle, 99,9 % of all bacteria is eliminated through high temperature heat. Use this cycle for clothing, bedding, towels, or other items needing sanitization.

## 3. Various Drying Cycles & Fuzzy Logic Algorithm

Simply turn the Jog Dial to select one of the 13 automatic drying cycles, including cotton, heavy duty and towels, or let the Fuzzy Logic Control measure the degree of dampness and automatically set the drying time. Precision drying has never been easier than with Samsung.

## 4. Energy Saving

Energy efficiency has been optimized to minimize unnecessary power consumption.

## 5. Easy Reversible Door

Our dryers will fit just about anywhere and without a door conflict. The direction of our easy reversible door can be changed with just four screws.

## 6. Pedestal with Storage Drawers

An optional 15" pedestal is available to raise the dryer for easier loading and unloading. It also offers a built-in storage drawer that can hold a 100 oz. bottle of detergent

## 7. Stacking (MODEL NO: SK-5A/XAA)

Samsung's Washers and Dryers can be stacked to maximize usable space.

 The Dryer legs need to be removed to stack the Washer and Dryer. You can purchase an optional stacking kit from your Samsung retailer.

## 8. 4-way Vent

You can install the exhaust vent in the following four (4) positions: back, either side, bottom.

# safety instructions

Congratulations on your new Samsung Dryer. This manual contains valuable information on the installation, use, and care of your appliance. Please take the time to read this manual to take full advantage of your dryer's many benefits and features.



## WARNING - Risk of Fire

- Clothes dryer installation must be performed by a qualified installer.
- Install the clothes dryer according to the manufacturer's instructions and local codes.
- Do not install a clothes dryer with flexible plastic venting materials. If flexible metal (foil type) duct is installed, it must be of a specific type identified by the appliance manufacturer as suitable for use with clothes dryers. Flexible venting materials are known to collapse, be easily crushed, and trap lint. These conditions will obstruct clothes dryer airflow and increase the risk of fire.
- To reduce the risk of severe injury or death, follow all installation instructions.

## WHAT YOU NEED TO KNOW ABOUT SAFETY INSTRUCTIONS

Warnings and Important Safety Instructions in this manual do not cover all possible conditions and situations that may occur. It is your responsibility to use common sense, caution, and care when installing, maintaining, or operating your dryer.

Always contact your manufacturer about problems or conditions you do not understand.

## IMPORTANT SAFETY SYMBOLS AND PRECAUTIONS

 <b>WARNING</b>	Hazards or unsafe practices that may result in <b>severe personal injury or death</b> . Follow the information in this manual to minimize the risk of fire or explosion or to prevent property damage, personal injury, or death. Do not store or use gasoline or other flammable vapors and liquids near this or any other appliance.
 <b>CAUTION</b>	Hazards or unsafe practices that may result in <b>minor personal injury or property damage</b> .
	Do NOT attempt.
	Do NOT disassemble.
	Do NOT touch.
	Follow directions explicitly.
	Make sure the machine is grounded to prevent electric shock.
	Call the service center for help.



# safety instructions

 This appliance is not intended for use by persons (including children) with reduced physical, sensory or mental capabilities, or lack of experience and knowledge, unless they have been given supervision or instruction concerning use of the appliance by a person responsible for their safety.

Children should be supervised to ensure that they do not play with the appliance.

 Never stop a tumble dryer before the end of the drying cycle unless all items are quickly removed and spread out so that the heat is dissipated.

## INSTRUCTION ABOUT THE WEEE MARK



### **Correct Disposal of This Product (Waste Electrical & Electronic Equipment)**

**(Applicable in the European Union and other European countries with separate collection systems)**

This marking on the product, accessories or literature indicates that the product and its electronic accessories (e.g. charger, headset, USB cable) should not be disposed of with other household waste at the end of their working life. To prevent possible harm to the environment or human health from uncontrolled waste disposal, please separate these items from other types of waste and recycle them responsibly to promote the sustainable reuse of material resources.

Household users should contact either the retailer where they purchased this product, or their local government office, for details of where and how they can take these items for environmentally safe recycling.

Business users should contact their supplier and check the terms and conditions of the purchase contract. This product and its electronic accessories should not be mixed with other commercial wastes for disposal.

## 4\_ Safety information





## SEVERE WARNING SIGNS FOR INSTALLATION

---



The installation of this appliance must be performed by a qualified technician or service company.

- Failure to do so may result in electric shock, fire, an explosion, problems with the product, or injury.

Keep all packaging materials well out of the reach of children, as packaging materials can be dangerous to children.

- If a child places a bag over its head, it may result in suffocation.
- 



This appliance must be properly grounded.

Do not ground the appliance to a gas pipe, plastic water pipe, or telephone line.

- This may result in electric shock, fire, an explosion, or problems with the product

Do not install or keep the product exposed to the outdoor elements.

# safety instructions



## SEVERE WARNING SIGNS FOR USING

- ★ Do not let children or pets on or into the product. In addition, when disposing of this product, disassemble the door lock (lever).
    - This may result in children falling and injuring themselves.
    - If children become locked in the product, there is a danger of suffocation.
  - Do not try to access the inside of the product when the drum is rotating.
  - Do not sit on the product or lean against the door.
    - This may result in the product turning over and resulting in injury.
  - Dry the laundry only after it was spun by an appropriate washing machine.
  - Do not dry unwashed items in the tumble dryer.
  - Do not drink the condensed water.
  - Never stop a tumble dryer before the end of the drying cycle unless all items are quickly removed and spread out so that the heat is dissipated.
  - Do not dry laundry contaminated by inflammable materials such as gasoline, kerosene, benzene, thinner, alcohol, etc.
    - This may result in electric shock, fire or explosion.
  - Do not let pets chew or play with the dryer.
    - This may result in electric shock or injury.
  - When disposing of the product, separate the door and the power cord before disposing of the product.
    - Failing to do so may result in damage to the power cord or an injury.
  - The product you have purchased is designed for domestic use only.
  - The use for business purposes qualifies as product misuse. In this case, the product will not be covered by the standard warranty provided by Samsung and no responsibility can be attributed to Samsung for malfunctions or damages resulting from such misuse.
- 
- ✂ Do not repair, replace, or attempt to service any part of the appliance unless specifically recommended in the user-repair instructions. You must also have the skills necessary to service this appliance.
- 
- ☐ Do not attempt to repair, disassemble, or modify the appliance yourself.
    - Do not use any fuse(such as cooper, steel wire, etc.) other than the standard fuse.
    - When repairing or reinstalling the appliance is required, contact your nearest service center.
    - Failure to do so may result in electric shock, fire, problems with the product, or injury.



## CAUTION SIGNS FOR USING

---



Do not stand on top of the appliance or place objects (such as laundry, lighted candles, lighted cigarettes, dishes, chemicals, metal objects, etc.) on the appliance.

- This may result in electric shock, fire, problems with the product, or injury.

Do not touch the glass door and inside of the drum during or just after drying as it is hot.

- This may result in burns.

Do not press the buttons using sharp objects such as pins, knives, fingernails, etc.

- This may result in electric shock or injury.

Do not use dry cleaning detergent directly and do not wash, rinse, or spin laundry contaminated by dry cleaning detergent.

- This may result in spontaneous combustion or ignition due to the heat of the oxidation of the oil.

Do not dry laundry containing forming rubber (latex) or similar rubber textures.

- If forming rubber is heated, it may start a fire.

Do not dry laundry contaminated by vegetable oil or cooking oil as a large amount of the oil will not be removed when washing the laundry. In addition, use the Cool Down cycle so that the laundry is not heated.

- The oxidization heat of the oil may start a fire.

Make sure that the pockets of all clothing to be washed are empty.

- Hard, sharp objects, such as coins, safety pins, nails, screws, or stones can cause extensive damage to the appliance.

Do not wash clothing with large buckles, buttons, or other heavy metal.

Do not use softener or a static electricity remover unless recommended by the manufacturer.

- This may result in damage to the laundry.

Do not use the dryer near dangerous powders such as coal dust, wheat flour, etc.

- This may result in electric shock, fire or an explosion.

Do not place inflammable materials near the product.

- This may result in toxic gases from the product, damage to parts, electric shock, fire or an explosion.
- The appliance should not be placed behind lockable doors etc.



## SEVERE WARNING SIGNS FOR CLEANING

---

Do not clean the appliance by spraying water directly onto it.

Do not use benzene, thinner or alcohol to clean the appliance.

- This may result in discolouration, deformation, damage, electric shock or fire.

Before cleaning or performing maintenance, cut off the power supply to the appliance.

- Failure to do so may result in electric shock or fire.

Clean the filter case before and after using the dryer.

Clean the inside of the product on a regular basis by asking an authorized service engineer.

Clean the condenser with water once a month.

The interior of the dryer should be cleaned periodically by qualified service personnel.

Safety information \_7

# contents



## INSTALLING YOUR DRYER

9

- 9 Tools needed for installation
- 9 See dryer exterior
- 10 Ducting requirements
- 11 Important to installer
- 11 Location considerations
- 12 Alcove or closet installation
- 14 Mobile home installation
- 14 Exhausting
- 14 Electrical requirements
- 14 Grounding
- 15 Replacement parts and accessories
- 15 Installation
- 16 Final installation checklist
- 17 Dryer exhaust tips
- 18 Door reversal

## OPERATING INSTRUCTIONS, TIPS

19

- 19 Overview of the control panel
- 22 Child lock 
- 22 Drum light 
- 22 My cycle
- 23 Rack dry
- 24 Clean the lint filter 
- 24 Load the dryer properly
- 24 Getting started

## CARE AND CLEANING

25

- 25 Control panel
- 25 Tumbler
- 25 Stainless steel tumbler
- 25 Dryer exterior
- 25 Dryer exhaust system

## SPECIAL LAUNDRY TIPS

26

- 26 Special laundry tips

## TROUBLESHOOTING

27

- 27 Check these points if your dryer...
- 28 Information codes

## APPENDIX

29

- 29 Fabric care chart
- 30 Protecting the environment
- 30 Declaration of conformity
- 30 Specifications
- 31 Cycle chart



# installing your dryer

## UNPACKING YOUR DRYER

Unpack your Dryer and inspect it for shipping damage. Make sure you have received all of the items shown below. If your Dryer was damaged during shipping, or you do not have all of the items, contact 0330 SAMSUNG (7267864)

 **WARNING** To prevent personal injury or strain, wear protective gloves whenever lifting or carrying the unit. Packing materials can be dangerous to children; keep all packing material (plastic bags, polystyrene, etc.) well out of the reach of children.

## SEE DRYER EXTERIOR

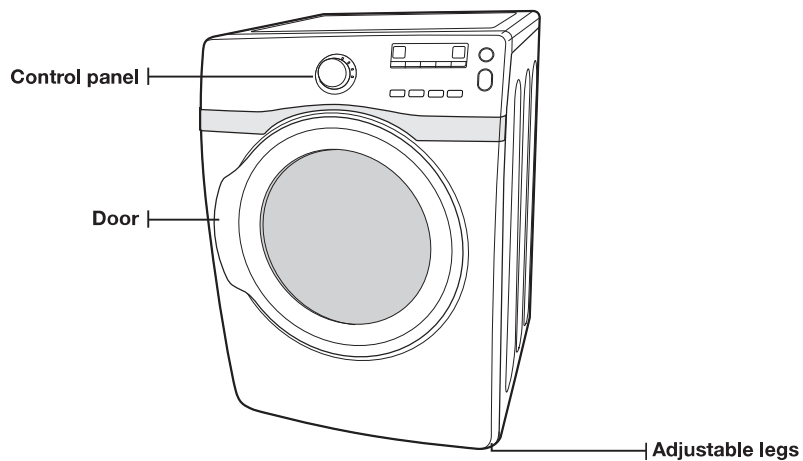

# installing your dryer

## DUCTING REQUIREMENTS

- Use a 4-inch (10.2 cm) diameter rigid aluminum or rigid galvanized steel duct.
- Do not use a smaller duct.
- Ducts larger than 4 inches (10.2 cm) in diameter can result in increased lint accumulation. Lint accumulation should be cleaned regularly.
- If a flexible metal duct must be used, use the type with a stiff sheet metal wall. Do not use a flexible duct with a thin foil wall. Serious blockage can result if the flexible metal duct is bent too sharply.
- Never install any type of flexible duct in walls, ceilings, or other concealed spaces.
- Only a rigid or flexible metal duct should be used for exhausting.
- Keep the exhaust duct as straight and short as possible.
- Secure joints with duct tape. Do not use screws.
- Do not exhaust dryer into any wall, ceiling, crawl space, or concealed space of a building, gas vent, or any other common duct or chimney. This could create a fire hazard from lint expelled by the dryer.
- A plastic flexible duct can kink, sag, be punctured, reduce airflow, extend drying times, and affect dryer operation.
- Exhaust systems longer than recommended can extend drying times, affect machine operation, and may collect lint.
- The exhaust duct should end with an exhaust hood with a swing-out damper to prevent back drafts and entry of wildlife. Never use an exhaust hood with a magnetic damper.
- The hood should have at least 12 inches (30.5 cm) of clearance between the bottom of the hood and the ground or other obstruction. The hood opening should point down.
- Never install a screen over the exhaust outlet.
- To avoid lint buildup, do not exhaust the dryer directly into a window well. Do not exhaust under a house or porch.
- If exhaust ductwork must run through an unheated area, the duct should be insulated and slope slightly down towards the exhaust hood to reduce condensation and lint buildup.
- Inspect and clean the interior of the exhaust system at least once a year.
- Check frequently to be sure the exhaust hood damper opens and closes freely.
- Check once per month, and clean at least one time per year. Note: If clothes are not getting dry, then check ducting for obstructions.

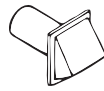
ELECTRIC AND GAS DRYER				
Weather Hood Type				
Recommended			Use only for short-run installation	
 4" (10.16 cm)			 2.5" (6.35 cm)	
No. of 90° elbows	Rigid	Metallic Flexible*	Rigid	Metallic Flexible*
0	24.4 m (80 ft.)	12.4 m (41 ft.)	22.6 m (74 ft.)	10.1 m (33 ft.)
1	20.7 m (68 ft.)	11.2 m (37 ft.)	18.9 m (62 ft.)	8.8 m (29 ft.)
2	17.4 m (57 ft.)	10.1 m (33 ft.)	15.5 m (51 ft.)	7.6 m (25 ft.)
3	14.3m (47 ft.)	9.0 m (29 ft.)	12.5 m (41 ft.)	6.5 m (21 ft.)

\* Do not use non-metallic flexible duct.

If the new dryer is installed into an existing exhaust system you must make sure:

- The exhaust system meets all local, state, and national codes.
- That a flexible plastic duct is not used.
- To Inspect and clean all lint buildup from inside the existing duct.
- The duct is not kinked or crushed.
- The exhaust hood damper opens and closes freely.

The static pressure in any exhaust system must not exceed 0.83 inches of water column, or be less than 0.

This can be measured with the dryer running with a manometer at the point where the exhaust duct connects to the dryer. A no-heat setting should be used. The dryer tumbler should be empty and the lint filter clean.

## IMPORTANT TO INSTALLER

Please read the following instructions carefully before installing the dryer. These instructions should be kept for future reference.



Remove the door from all discarded appliances to avoid the danger of a child suffocating.

## LOCATION CONSIDERATIONS

The dryer should be located where there is enough space at the front for loading the dryer, and enough space behind for the exhaust system. This dryer is factory-ready for rear exhaust. To exhaust out the bottom or the right or the left, use the accessory exhaust kit. Instructions are included with the kit. It's important to make sure the room has enough fresh air. The dryer must be located where there is no air-flow obstruction.

On gas dryers, adequate clearance as noted on the data plate must be maintained to ensure adequate air for combustion and proper dryer operation.

The dryer must not be installed or stored in an area where it will be exposed to water and/or weather. The dryer area is to be kept clear of combustible materials, gasoline, and other flammable vapors and liquids. A dryer produces combustible lint. The area around the dryer should be kept lint-free.

# installing your dryer

## ALCOVE OR CLOSET INSTALLATION

### MINIMUM CLEARANCES FOR CLOSET AND ALCOVE INSTALLATIONS:

Sides – 1 in / 25 mm

Top – 17 in / 432 mm

Rear – 5 in / 127 mm

Closet Front – 2 in / 51 mm

If the washer and dryer are installed together, the closet front must have at least a 72 in<sup>2</sup> (465 cm<sup>2</sup>) unobstructed air opening.

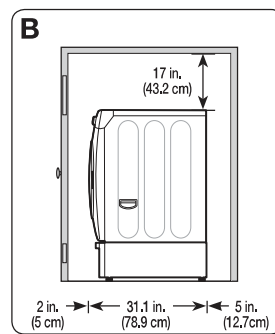
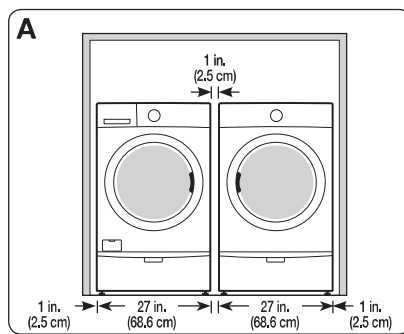

A. Recessed area

B. Side view - closet or confined area

With optional pedestal base or stacking kit

Required Dimensions for Installation With Pedestal

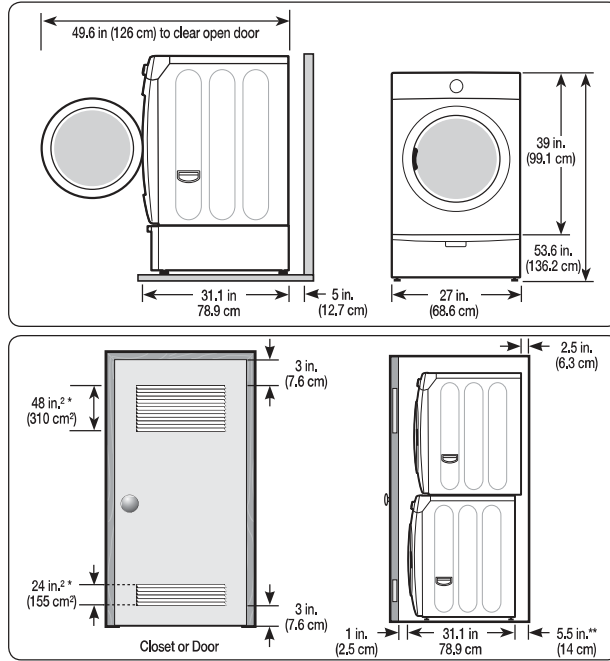

Required Dimensions for Installation With Stacking Kit

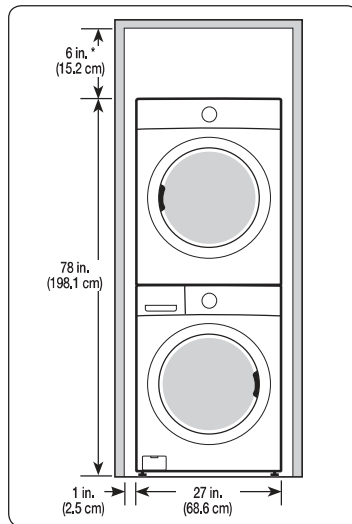

\* Required spacing  
 \*\* External exhaust elbow requires additional space.

# installing your dryer

## MOBILE HOME INSTALLATION

When installing a dryer in a mobile home, provisions for anchoring the dryer to the floor must be made. Locate an area that has adequate fresh air.

A minimum of 72 in<sup>2</sup> (465 cm<sup>2</sup>) of unobstructed space is required.

Call 0330 SAMSUNG (7267864) for information on purchasing the Floor Anchoring Kit as an accessory.

All mobile home installations must be exhausted to the outside with the exhaust duct termination securely fastened to the mobile home structure, using materials that will not support combustion.

The exhaust duct may not terminate underneath the mobile home.

See Exhausting section for more information.

## EXHAUSTING

Exhausting the dryer to the outside will prevent large amounts of lint and moisture from being blown into the room.



The dryer must be exhausted to the outside to reduce the risk of fire when installed in an alcove or closet.

Never use a plastic or non-metal flexible duct.

If your existing ductwork is plastic, non-metal, or combustible, replace it with metal.

Use only a metal exhaust duct that is non-flammable to ensure containment of exhaust air, heat, and lint.

## ELECTRICAL REQUIREMENTS



- Improper connection of the equipment grounding conductor can result in a risk of electric shock. Check with a qualified electrician or serviceman if you are in doubt as to whether your dryer is properly grounded.
- To prevent unnecessary risk of fire, electrical shock, or personal injury, all wiring and grounding must be done in accordance with local codes.
- The impedance of power supply system must be maintained under 0,0018. Not connect a dryer to general power supply system.

## GROUNDING

This dryer must be grounded. In the event of malfunction or breakdown, the ground will reduce the risk of electrical shock by providing a path of least resistance for the electrical current.



### Electric models

Your dryer has a cord with an equipment-grounding conductor and a grounding plug, sold separately.

The plug must be plugged into an appropriate outlet that is properly installed and grounded in accordance with all local codes and ordinances.

Do not modify the plug provided with your dryer – if it doesn't fit the outlet, have a proper outlet installed by a qualified electrician.

If a power cord is not used and the electric dryer is to be permanently wired, the dryer must be connected to a permanently grounded metal wiring system, or an equipment grounding conductor must be run with the circuit conductors and connected to the equipment grounding terminal.

## REPLACEMENT PARTS AND ACCESSORIES

If your dryer requires replacement parts or accessories, contact the dealer from whom you purchased your dryer or the SAMSUNG customer care center at 0330 SAMSUNG (7267864).

## INSTALLATION

Gather the required tools and parts before starting the installation.  
Read and follow the instructions provided with any tools listed here.

### Tools and Parts



Pliers

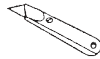

Cutting knife

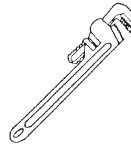

Pipe wrench (gas only)

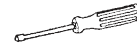

Nut drivers



Level



Phillips Screwdriver



Duct tape

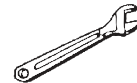



Wrench

For proper installation, we recommend that you hire a professional. To install:

1. Move your dryer to an appropriate location for installation. Consider installing the dryer and washer side-by-side, to allow access to gas, electrical, and exhaust connections. Lay two of the carton cushion-tops on the floor. Tip your dryer on its side so it will lay across both cushion-tops.
2. Set your dryer back in an upright position.
3. To ensure that the dryer provides optimal drying performance, it must be level. To minimize vibration, noise, and unwanted movement, the floor must be a perfectly level, solid surface.

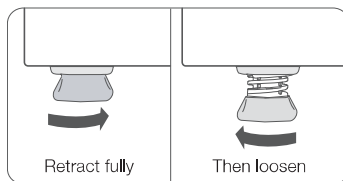
-  To set the dryer to the same height as the washer, fully retract the levelling feet by turning them counterclockwise, then loosen the legs by turning them clockwise



-  Adjust the levelling feet only as much as necessary to level the dryer. Extending the levelling feet more than necessary can cause the dryer to vibrate.

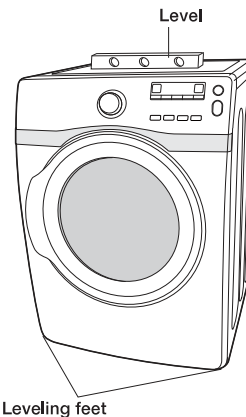

# installing your dryer

4. Review the Exhausting section before installing the exhaust system. Install the ductwork from your dryer to the exhaust hood. The crimped end of the duct sections must point away from your dryer. DO NOT use sheet metal screws when assembling ducting. These joints should be taped.

**Never use plastic flexible exhaust material.**

Tip for tight installations: install a section of exhaust system to your dryer before putting it in place. Use duct tape to secure this section to your dryer, but do not cover ventilation slots at the back of the unit in the dryer cabinet.

5. Review Electrical Requirements section. BEFORE OPERATING OR TESTING, follow the grounding instructions in the Grounding section.

**IMPORTANT** – The dryer is produced for a **3-WIRE SYSTEM CONNECTION.**

The dryer frame is grounded to the neutral conductor at the terminal block.

Remove the terminal block cover plate.

Insert the power cord through the hole provided in the cabinet near the terminal block.

 A strain relief must be used.

Do not loosen the nuts already installed on the terminal block. Be sure they are tight. Use a 3/8" (1cm) deep well socket.

### 3-WIRE system connections

- A. External ground connector
- B. Neutral grounding wire (green/yellow)
- C. Center silver-colored terminal block screw
- D. Earth wire
- E. strain relief

1. Loosen or remove the center terminal block screw.
2. Connect the neutral wire (white or center wire) of the power cord to the center, silver-colored terminal screw of the terminal block. Tighten screw.
3. Connect the other wires to outer terminal block screws. Tighten screws.
4. Tighten the strain relief screws.
5. Insert the tab of the terminal block cover into your Dryer's rear panel slot. Secure the cover with a hold-down screw.

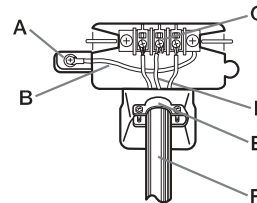

- F. The power cable H05 VV-F (min.1.9m, min.2.5mm<sup>2</sup>) must be of sufficient length to be connected to the dryer.

6. With a level, check your dryer and make necessary adjustments to the levelling legs.
7. At this time, make sure all exhaust and electrical connections are complete. Connect your dryer to the power supply, and check operation by using the checklist below.
8. A minimum 30A circuit breaker should be used, and a switch with a minimum contact separation of 3 mm in both poles must be incorporated into the fixed wiring for dryer disconnection. The dryer should be positioned so that the disconnection switch is easily accessible to the user.

## FINAL INSTALLATION CHECKLIST

- Dryer is connected to the power supply and is properly grounded.
- Exhaust ductwork is hooked up and joints are taped.
- Plastic flexible duct is NOT used.
- Used rigid or stiff-walled flexible metal vent material.
- Dryer is leveled and is sitting firmly on the floor.
- Start your dryer to confirm that it runs, heats, and shuts off.

16\_ installing your dryer



## DRYER EXHAUST TIPS



Plastic or non-metal flexible duct presents a potential fire hazard.

1. Make sure your dryer is installed properly so it exhausts air easily.

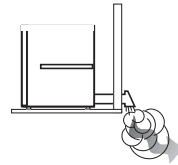

2. Use a 4" diameter rigid metal duct. Tape all joints, including at the dryer. Never use lint-trapping screws.

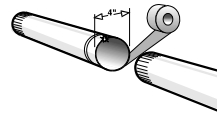

3. Keep ducts as straight as possible.

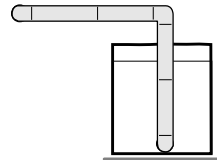

4. Clean all old ducts before installing your new dryer. Be sure the vent flap opens and closes freely. Inspect and clean the exhaust system annually.

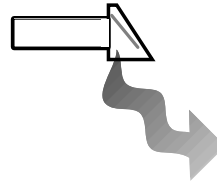

Don't let a poor exhaust system slow drying by:

1. Restricting your dryer with a poor exhaust system.
2. Using a plastic, thin foil, or non-metal flexible duct.
3. Unnecessarily using long ducts that have many elbows.
4. Having crushed or clogged ducts and vent.

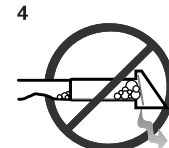
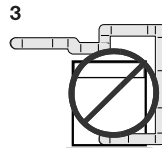
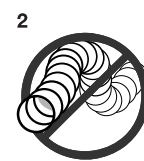

# installing your dryer

## DOOR REVERSAL

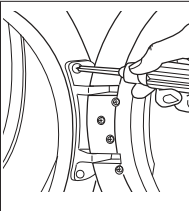
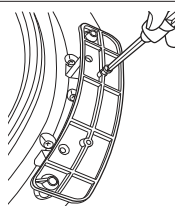
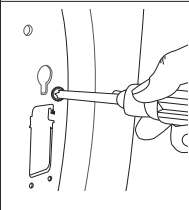
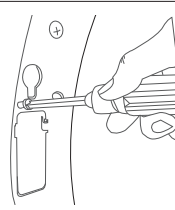
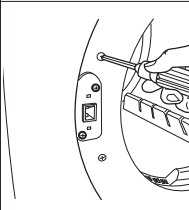
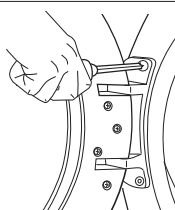
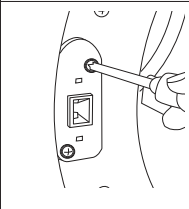
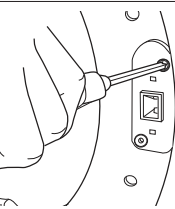
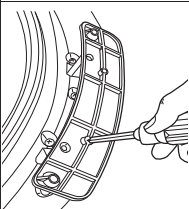
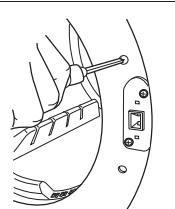
<p><b>1.</b> Cut off the power supply. <b>2.</b> Remove two door hinge screws. <b>3.</b> Lift the door and remove it.</p>		<p><b>8.</b> Reinsert the screw in the other hole.</p>	
<p><b>4.</b> Remove a screw on the Frame Front</p>		<p><b>9.</b> Reinsert the screw (Step 4) on the Frame Front</p>	
<p><b>5.</b> Remove the two screws on the opposite side of the door hinge.</p>		<p><b>10.</b> Place the door on the other side and reattach it to the dryer.</p>	
<p><b>6.</b> Remove two screws from the holder lever.</p>		<p><b>11.</b> Reattach the holder lever.</p>	
<p><b>7.</b> Remove a screw from the door hinge.</p>		<p><b>12.</b> Reattach the screws in the remaining holes.</p>	

# operating instructions, tips

## OVERVIEW OF THE CONTROL PANEL

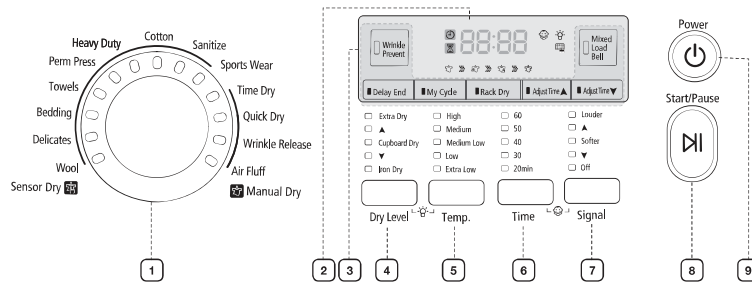

### 1 Cycle Selector

To select a cycle, rotate the Cycle Selector dial to the desired cycle.

The indicator light by the cycle name will illuminate. The Sports Wear, Sanitize, Cotton, Heavy duty, Perm Press, Towels, Bedding, Delicates and wool cycles are Sensor Dry cycles.

Sensor Dry automatically senses the moisture in the load and shuts the dryer off when the selected dryness level (very dry to damp dry) is reached.

**Cotton** – Use this cycle to dry loads such as cotton, underwear, and linen.

**Heavy Duty** – Use this cycle to get high heat for heavy fabrics such as jeans, corduroys, or work clothes.

**Perm Press** – Dry wrinkle-free cottons, synthetic fabrics, knits, and permanent press fabrics automatically.

**Towels** – Dry loads such as bath towels.

**Bedding** – For bulky items such as blankets, sheets and comforters.

**Delicates** – The Delicates cycle is designed to dry heat-sensitive items at a low drying temperature.

**Wool** – For machine washable and tumble dryable wool only.

**Sanitize** - This course allows you to sanitize garments by permeating high temperature heat deep into the fabric during the drying cycle. Use this course to keep your bedding and curtains clean through sanitization.

**Sports Wear** - Use for water-proofed or proofed garments to keep their good looks and fresh feel (except Gore-Tax).

For better drying results, turn the laundry inside out before drying it.

**Time Dry** – Time Dry allows you to select the desired cycle time in minutes.

Turn the Cycle Selector dial to Time Dry, then press the Adjust Time up arrow to set the drying time.

Press the arrow repeatedly to scroll through the time settings.

**Quick Dry** – Provides a 30 minute drying cycle.

**Air Fluff** – The Air Fluff cycle tumbles the load in room temperature air.

**Wrinkle Release** – The Wrinkle Release cycle will release wrinkles from items that are clean, dry, and only slightly wrinkled, such as clothes from a crowded closet, suitcase or items that have been in the dryer too long after the cycle has ended. Wrinkle Release can be used with any temperature selection.

 Overloading the dryer may not yield the same results..

# operating instructions, tips

<p><b>2 Digital Graphic Display</b></p>	<p>The display window shows the estimated time remaining in the cycle after the Start/Pause button is pressed. The estimated time remaining may fluctuate as the cycle progresses. (🕒)</p> <p>The Drying light will illuminate and remain lit until the cycle is complete. (💡)</p> <p>When your dryer is in the cool-down phase, the Cooling light will illuminate. (❄️)</p> <p>When your dryer is in the wrinkle prevent phase, the Wrinkle Prevent light will illuminate. (🛑)</p> <p>When the cycle is complete, "End" will appear in the display panel until the dryer door is opened or the Power button is pushed. (🏠)</p> <p>If your dryer is paused during a cycle, the indicator lights will blink until the Start/Pause button is pressed.</p>
<p><b>3 Select Cycle Option</b></p>	<p><b>Wrinkle Prevent</b> -Wrinkle Prevent provides approximately 180 minutes of intermittent tumbling in unheated air at the end of the cycle to reduce wrinkling. Press the Wrinkle Prevent button to activate this feature.</p> <p>The indicator light above the pad will illuminate when Wrinkle Prevent is selected. The load is dry, and can be removed at any time during the Wrinkle Prevent cycle.</p> <p><b>Mixed Load Bell</b> - This is an alarm that notifies the user when the average dry level is damp dry (80 % dried). This is useful when the laundry contains various types of clothing you do not want to dry completely. An alarm sounds for five (5) seconds while continuing to perform the cycle.</p> <p>This function can only be selected in the Sensor Dry course, and the dry level can only be selected from Cupboard Dry to Extra Dry.</p> <p><b>Delay End</b> : You can set the dryer to finish your drying cycle automatically at a later time, choosing a delay of between 4 to 24 hours (in 1 hour increments). The hour displayed indicates the time at which the dry will be finished. (🕒)</p> <ol style="list-style-type: none"> <li>1. Manually or automatically set your drying machine according to the type of laundry you are drying.</li> <li>2. Press the Delay End button repeatedly until the required delay time is set. If the delay time is set, the "Delay End" function becomes ON state.</li> <li>3. Press the Start/Pause button, The "Delay End " indicator will blink and the clock will begin counting down until it reaches the set time.</li> <li>4. To cancel a Delay End function, press the Power button and then turn the dryer on again.</li> </ol> <p><b>My Cycle</b> : Choose your favorite cycle including cycle, temp, dry level option, etc. (See page 22 for detail.)</p> <p><b>Rack Dry</b> : Rack Dry is available at Time Dry cycle. Temperature will be set only to Extra Low. (See page 23 for detail.)</p> <p><b>Adjust Time</b> – Time can be added or subtracted from the automatically set times in the Manual Dry cycles (Time Dry, Quick Dry, Air Fluff cycles).</p> <p>To add or subtract time from the cycle, press the Adjust Time arrow pad up or down until the desired time is displayed.</p>
<p><b>4 Dry Level Selection Button</b></p>	<p>To select the dry level in the Sensor Dry cycles, press the Dry Level button. An indicator light will illuminate next to the desired dryness level.</p> <p>Press the button repeatedly to scroll through the settings.</p>

<p><b>5 Temp Selection Button</b></p>	<p>To select the correct temperature for the load, press the Temp button. An indicator light will illuminate next to the desired temperature. Press the button repeatedly to scroll through the settings.</p> <p><b>High</b> – For sturdy cottons or those labeled Tumble Dry.</p> <p><b>Medium</b> – For permanent press, synthetics, lightweight cottons, or items labeled Tumble Dry Medium.</p> <p><b>Medium Low</b> – For lower heat than Medium to dry synthetic or washable knit fabrics.</p> <p><b>Low</b> – For heat sensitive items labeled Tumble Dry Low or Tumble Dry Warm.</p> <p><b>Extra Low</b> – Provides the lowest heated dry temperature possible.</p>
<p><b>6 Time Selection Button</b></p>	<p>When using Manual Dry cycles, time can be adjusted by pressing the Time Selection button.</p> <p>During the Sensory Dry cycle, the time light indicator is off because exact drying times are determined by fluctuating humidity levels.</p>
<p><b>7 Signal Selection Button</b></p>	<p>When the cycle is complete, a chime will sound.</p> <p>When the Wrinkle Prevent option is selected, the chime will sound intermittently. Adjust the volume of the chime or turn it off by pressing the Signal button. Press the button repeatedly to scroll through the choices.</p>
<p><b>8 Start/Pause selection button</b></p>	<p>Press to pause and restart programs.</p>
<p><b>9 Power button</b></p>	<p>Press once to turn your dryer on, press again to turn it off. If your dryer is left on for more than 10 minutes without any buttons being touched, the power automatically turns off.</p>



Do not dry unwashed items in the tumble dryer



Never stop a tumble dryer before the end of the drying cycle unless all items are quickly removed and spread out so that the heat is dissipated.

# operating instructions, tips

## CHILD LOCK

A function to prevent children from playing with your dryer.

### Setting/Releasing

If you want to set or release the Child Lock, press both the **Time** and **Signal** buttons simultaneously for 3 seconds.

#### How to Set:

1. It can be set while your dryer is running.
2. Once you set the Child Lock function, no button, except for the Power button, will respond until you release the Child Lock function.
3. The Child Lock indicator will be lit.

-  1. If the dryer is powered on again, the Child Lock function stays on.
- 2. To release that function, follow the instructions above.

-  When other buttons, except for the Power button, do not respond, check the Child Lock indicator.

## DRUM LIGHT

Lights the dryer drum while the dryer is running.

### Setting & releasing

If you want to set or release the Drum Light, press both the **Dry Level** and **Temp.** buttons simultaneously.

-  It can be set while your dryer is not only running but also when it is stopped. If you do not turn the Drum Light off within 5 minutes of turning it on, it is automatically turned off.

## MY CYCLE

Lets you activate your customized cycle that includes Dry Level, Temp, Time option, etc.

By pushing the My Cycle button, you activate the settings used during the previous My Cycle mode. (Default : Cotton Cycle)

If My Cycle mode is activated, the My Cycle indicator will be lit.

You can select all options in My Cycle mode as follows.

1. Select cycle using the Cycle Selector dial.
2. After cycle selection, set each option.

-  Each cycle has certain default options that are automatically set. To see these default options, go to page 31.

3. Then, you can start My Cycle by pushing the Start/Pause button in My Cycle mode. The cycle and options you select will be displayed the next time you choose My Cycle.

-  You can change the My Cycle settings by repeating the same process above. The last used setting will be displayed the next time you choose My Cycle.

## RACK DRY

### Installing the drying rack

1. Open the dryer door.
2. Position drying rack in tumbler, placing the front lip of the drying rack on the top of the lint filter.
3. Place the rear legs in the two recessed areas of the dryer's back wall then push down the middle of the drying rack to fix.
4. Place the items to be dried on the rack, leaving space between them so air can circulate.
5. Close the dryer door.
6. Press the RACK DRY button at Time Dry cycle and then select the time according to the moisture and weight of item. The drying rack can be also used at Air Fluff cycle.

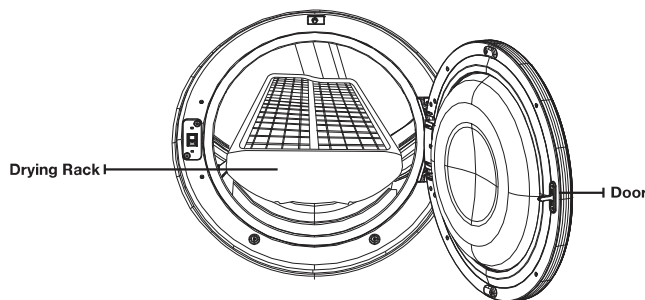

SUGGESTED ITEMS	SUGGESTED TEMP. SETTINGS
Washable sweaters (block to shape and lay flat on rack)	Extra Low ( Time Dry cycle)
Stuffed toys (cotton or polyester fiberfilled)	Extra Low ( Time Dry cycle)
Stuffed toys (foam or rubber-filled)	Air Fluff
Foam rubber pillows	Air Fluff
Sneakers	Air Fluff

**WARNING** Drying foam rubber, plastic, or rubber on a heat setting may cause damage to the items or lead to a fire hazard.

# operating instructions, tips

## CLEAN THE LINT FILTER

- After each load.
- To shorten drying time.
- To operate more energy efficiently.

 Do not operate your dryer without the lint filter in place.

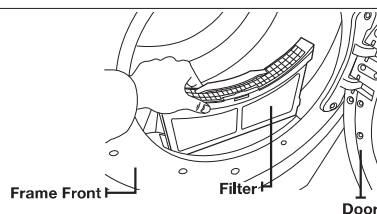



## LOAD THE DRYER PROPERLY

- Place only one washload in your dryer at a time.
- Mixed loads of heavy and lightweight fabrics will dry differently, which may result in lightweight fabrics being dry while heavy fabrics remain damp at the end of a drying cycle.
- Add one or more similar items to your dryer when only one or two articles of clothing need drying. This improves the tumbling action and drying efficiency.
- Overloading restricts tumbling action, resulting in uneven drying as well as excessive wrinkling of some fabrics.

 **WARNING** Overloading may cause the dryer door open while drying.

## GETTING STARTED

1. Load your dryer loosely – DO NOT overload.
  2. Close the door.
  3. Select the appropriate cycle and options for the load (see pages 19-21).
  4. Press the Start/Pause button.
  5. The dryer indicator light will illuminate.
  6. The estimated cycle time will appear in the display.  
The time may fluctuate to better indicate drying time remaining in the cycle.
-  • When the cycle is complete, the Door Lock light will go out and “End” will appear in the display.
- Pressing Power cancels the cycle and stops your dryer.
  - The Drying, Cooling, and Wrinkle Prevent indicator lights will illuminate during those portions of the cycle.

 **WARNING** Do not place anything on top of your dryer while it is running.



# care and cleaning

## CONTROL PANEL

Clean with a soft, damp cloth. Do not use abrasive substances.

Do not spray cleaners directly on the panel.

The control panel finish may be damaged by some laundry pre-treatment soil and stain remover products.

Apply such products away from your dryer and wipe up any spills or overspray immediately.

## TUMBLER

Remove any stains such as crayon, ink, or fabric dye (from new items such as towels or jeans) with an all-purpose cleaner.

Tumble old towels or rags to remove any excess stain or cleaning substance.

Once these steps are followed, stains may still be visible, but should not transfer to subsequent loads.

## STAINLESS STEEL TUMBLER

To clean the stainless steel tumbler, use a damp cloth with a mild, non-abrasive cleaner suitable for stainless steel surfaces.

Remove the cleaner residue and dry with a clean cloth.

## DRYER EXTERIOR

The entire dryer has a high-gloss finish. Clean with a soft, damp cloth. Do not use abrasive substances.

Protect the surface from sharp objects as they may scratch or damage the finish.

Do not place any heavy or sharp objects or a detergent box on the dryer. Keep them on the purchased pedestal or in a separate storage box.

## DRYER EXHAUST SYSTEM

Should be inspected and cleaned yearly to maintain optimum performance.

The outside exhaust hood should be cleaned more frequently to ensure proper operation.

-  Do not use industrial chemical such as benzene, thinner or alcohol to clean the appliance.
- This may result in discolouration, deformation, damage, electric shock or fire.

# special laundry tips

## SPECIAL LAUNDRY TIPS

Please follow the care label or manufacturer's instructions for drying special items. If care label instructions are not available, use the following information as a guide.

<b>Bedspreads &amp; Comforters</b>	<ul style="list-style-type: none"><li>• Follow the care label instructions or dry on the Cotton cycle and High temperature.</li><li>• Make sure the item is thoroughly dry before using or storing.</li><li>• May require repositioning to ensure even drying.</li></ul>
<b>Blankets</b>	<ul style="list-style-type: none"><li>• Use Cotton cycle and dry only one blanket at a time for best tumbling action.</li><li>• Make sure the item is thoroughly dry before using or storing.</li></ul>
<b>Curtains &amp; Draperies</b>	<ul style="list-style-type: none"><li>• Use the Perm Press cycle and medium temperature to help minimize wrinkling.</li><li>• Dry in small loads for best results and remove as soon as possible.</li></ul>
<b>Cloth Diapers</b>	<ul style="list-style-type: none"><li>• Use the Cotton cycle and the High temperature settings for soft, fluffy diapers.</li></ul>
<b>Down-filled Items (jackets, sleeping bags, comforters, etc.)</b>	<ul style="list-style-type: none"><li>• Use the Cotton cycle and medium temperature setting.</li><li>• Adding a couple of dry towels shortens drying time and absorbs moisture.</li></ul>
<b>Pillows</b>	<ul style="list-style-type: none"><li>• Use the Cotton cycle.</li><li>• Add a couple of dry towels to help the tumbling action and to fluff the item.</li><li>• DO NOT dry kapok or foam pillows in dryer.</li></ul>
<b>Plastics (shower curtains, outdoor furniture covers, etc.)</b>	<ul style="list-style-type: none"><li>• Use the Time Dry cycle and the Low or Extra Low temperature settings depending on the care label instructions.</li></ul>

### THINGS TO AVOID :

- Fiberglass items (curtains, draperies, etc.).
- Woolens, unless recommended on the label.
- Vegetable or cooking oil-soaked items.
- Foam Rubber (rug backs, stuffed toys, shoulder pads, etc.)

# troubleshooting

## CHECK THESE POINTS IF YOUR DRYER...

PROBLEM	SOLUTION
Doesn't run.	<ul style="list-style-type: none"> <li>• Make sure the door is latched shut.</li> <li>• Be sure the power supply cord is fixed into a live electrical outlet.</li> <li>• Check the home's circuit breaker and fuses.</li> <li>• Press the Start/Pause button again if the door is opened during the cycle.</li> </ul>
Doesn't heat.	<ul style="list-style-type: none"> <li>• Check the home's circuit breaker and fuses.</li> <li>• Clean the lint filter and exhaust duct.</li> <li>• Dryer may have moved into the cool-down phase of the cycle.</li> </ul>
Doesn't dry.	<ul style="list-style-type: none"> <li>• Check all of the above, plus...</li> <li>• Be sure the exhaust hood outside the home can open and close freely.</li> <li>• Check exhaust system for lint buildup. Ducting should be inspected and cleaned annually.</li> <li>• Use a 4" rigid metal exhaust duct.</li> <li>• Do not overload. 1 wash load = 1 dryer load.</li> <li>• Sort heavy items from lightweight items.</li> <li>• Large, bulky items like blankets or comforters may require repositioning to ensure even drying.</li> <li>• Check that the washer is draining properly to extract adequate water from the load.</li> <li>• Load may be too small to tumble properly. Add a few towels.</li> </ul>
Is noisy.	<ul style="list-style-type: none"> <li>• Check the load for objects such as coins, loose buttons, nails, etc. Remove promptly.</li> <li>• It is normal to hear the heating element cycle on and off during the drying cycle.</li> <li>• Be sure the dryer is levelled properly as outlined in the installation instructions.</li> <li>• It is normal for the dryer to hum due to the high velocity of air moving through the dryer drum and exhaust system.</li> </ul>
Dries unevenly.	<ul style="list-style-type: none"> <li>• Seams, pockets, and other similarly heavy areas may not be completely dry when the rest of the load has reached the selected dryness level. This is normal. Select the More Dry setting if desired.</li> <li>• If one heavy item is dried with a lightweight load, such as one towel with sheets, it is possible that the heavy item will not be completely dry when the rest of the load has reached the selected dryness level. Sort heavy items from lightweight items for best drying results.</li> </ul>
Has an odour.	<ul style="list-style-type: none"> <li>• Household odours from painting, varnishing, strong cleaners, etc. may enter the dryer with the surrounding room air. This is normal as the dryer draws the air from the room, heats it, pulls it through the tumbler, and exhausts it outside.</li> <li>• When these odours linger in the air, ventilate the room completely before using the dryer.</li> </ul>
Shuts off before load is dry	<ul style="list-style-type: none"> <li>• Dryer load is too small. Add more items or a few towels and restart the cycle.</li> <li>• Dryer load is too large. Remove some items and restart the dryer.</li> </ul>

# troubleshooting

PROBLEM	SOLUTION
<b>Lint on clothes</b>	<ul style="list-style-type: none"> <li>• Make sure the lint filter is cleaned before every load. With some loads that produce high amounts of lint, it may be necessary to clean the filter during the cycle.</li> <li>• Some fabrics are lint producers (for example, a fuzzy white cotton towel) and they should be dried separately from clothes that are lint trappers (for example, a pair of black linen pants)</li> <li>• Divide larger loads into smaller loads for drying</li> <li>• Check pockets thoroughly before washing and drying clothes.</li> </ul>
<b>Garments still wrinkled after Wrinkle-Release</b>	<ul style="list-style-type: none"> <li>• Small loads of 1 to 4 items work best.</li> <li>• Load fewer garments. Load similar-type garments.</li> </ul>

## INFORMATION CODES

Information codes may be displayed to help you better understand what is occurring with your Dryer.



































ERROR DISPLAY	MEANING	SOLUTION
<b>tE</b>	Clogged Lint Screen Vent is restricted	Clean the screen or vent. If the problem continues, call for service.
<b>HE</b>	Invalid heating Temp in running the dryer	Call for service.
<b>dE</b>	Running the dryer with door open	Close the door and then restart. If the problem continues, call for service.
<b>dF</b>	Door is not closing properly	Call for service.
<b>bE2</b>	Unit detects a button is being pressed for over 30secs or button is stuck	Make sure a button is NOT being pressed continuously. If the problem continues call for service.
<b>FE</b>	Invalid power source Frequency	Try restarting the cycle. If the problem continues, call for service.
<b>AE</b>	Electronic Control Problem (Communication Error)	Call for service.

For any codes not listed above, call 0330 SAMSUNG (7267864).

# appendix

## FABRIC CARE CHART

The following symbols provide garment care direction. The Clothing care labels include symbols for washing, bleaching, drying and ironing, or dry cleaning when necessary. The use of symbols ensures consistency among garment manufacturers of domestic and imported items. Follow care label directions to maximize garment life and reduce laundering problems.

Wash Cycle		Special Instructions		Warning Symbols for Laundering	
	Normal		Line Dry/ Hang to Dry		Do Not Wash
	Permanent Press / Wrinkle Resistant / Wrinkle Control		Drip Dry		Do Not Wring
	Gentle/Delicates		Dry Flat		Do Not Bleach
	Hand Wash	<b>Heat Setting</b>			Do Not Tumble Dry
<b>Water Temperature**</b>			High		No Steam (added to iron)
	Hot		Medium		Do Not Iron
	Warm		Low	<b>Dryclean</b>	
	Cold		Any Heat		Dry Clean
<b>Bleach</b>			No Heat/Air		Do Not Dry Clean
	Any Bleach (when needed)	<b>Iron-Dry or Steam Temperatures</b>			Line Dry/ Hang to Dry
	Only Non-Chlorine (colour-safe) Bleach (when needed)		High		Drip Dry
	Tumble Dry Cycle		Medium		Dry Flat
<b>Normal</b>			Low		
	Permanent Press/ Wrinkle Resistant/ Wrinkle Control				
	Gentle/ Delicates				

\*\* The dot symbols represent appropriate wash water temperatures for various items. The temperature range for Hot is 105° – 125 °F / 41° – 52 °C, for Warm 85° – 105 °F / 29° – 41 °C and for Cold 60° – 85 °F / 16° – 29 °C. (Wash water temperature must be a minimum of 60 °F / 16 °C for detergent activation and effective cleaning.)

# appendix

## PROTECTING THE ENVIRONMENT

This appliance is manufactured from recyclable materials. If you decide to dispose of this appliance, please observe local waste disposal regulations. Cut off the power cord so that the appliance cannot be connected to a power source. Remove the door so that animals and small children cannot get trapped inside the appliance.

## DECLARATION OF CONFORMITY

This appliance complies with European safety standards, EC directive 93/68 and EN Standard 60335

## SPECIFICATIONS

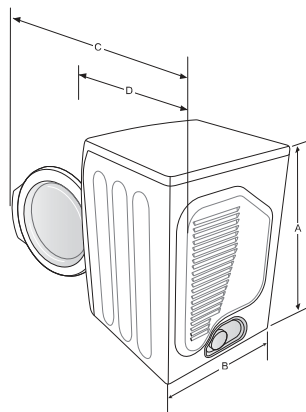

TYPE	FRONT LOADING DRYER			
DRYING CAPACITY	10kg			
DIMENSIONS	Div	Inches (cm)	Div	Inches (cm)
	A. Height	39" (99.1)	C. Depth with door open 90°	49.6" (126.0)
	B. Width	27" (68.6)	D. Depth	31.1" (78.9)
WEIGHT	126.1lb (57.2kg)			
HEATER RATING	4700 W			
POWER CONSUMPTION	NO HEAT		200 W	
	HEATING		4900 W	

## CYCLE CHART

(● : factory setting, ◦ : selectable)

Cycle		FUNCTIONS										OPTIONS		
		Sensor dry level					Temp control					TIME	Wrinkle Prevent	Delay End
		Extra	▲	Cupboard	▼	Iron	High	Medium	Med Low	Low	Extra Low			
Sensor Dry	Cotton	◦	◦	●	◦	◦	●	◦					◦	◦
	Heavy Duty	◦	◦	●	◦	◦	●						◦	◦
	Perm Press	◦	◦	●	◦	◦		●					◦	◦
	Bedding	◦	◦	●	◦	◦	●						◦	◦
	Towels	◦	◦	●	◦	◦	●	◦					◦	◦
	Sanitize	●					●						◦	◦
	Delicates	◦	◦	●	◦	◦					●		◦	◦
	Wool			●						●			◦	◦
	Sports wear	◦	◦	●	◦	◦					●		◦	◦
Manual Dry	Air Fluff										◦	◦	◦	◦
	Quick dry						●				◦	◦	◦	◦
	Time dry						●	◦	◦	◦	◦	◦	◦	◦
	Wrinkle Release							●	◦	◦	◦	◦	◦	◦

※ Other cycle options refer to page 21.



QUESTIONS OR COMMENTS?

Country	CALL	OR VISIT US ONLINE AT
U.K	0330 SAMSUNG (7267864)	<a href="http://www.samsung.com">www.samsung.com</a>
EIRE	0818 717100	<a href="http://www.samsung.com">www.samsung.com</a>

Code No. DC68-03021E\_EN